



SwishPlant™ System Catalog



SwishPlant™



4.8mmD
4.1mmD



4.8mmD
4.8mmD



3.7mmD
3.3mmD



6.5mmD
4.8mmD



6.5mmD
5.7mmD



Table of Contents



SwishPlant Fixture Mount
Packaging

Page #

1

2-3

Implant Design and Surface



SwishPlant Implants

4-5

6

Selection Chart for
Straight Abutments,
Transfers & Analogs



Straight Abutment &
Ancillary Components

7

8

Selection Chart for
Cemented Restorations

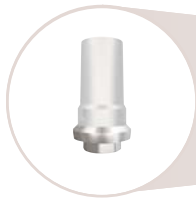

Engaging and
Non-Engaging Abutments

9

10

Selection Chart for
Overdenture & Screw-Retained
Restorations



Overdenture &
Screw-Retained Restorative
Components

11

12

Locator® Abutments
and Components

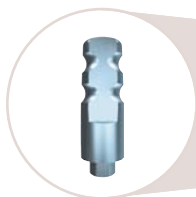
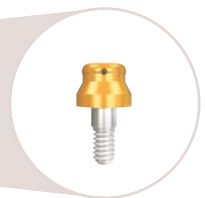

Cover Screws, Healing
Collars, Transfers & Analogs

13

14

Surgical Sequence

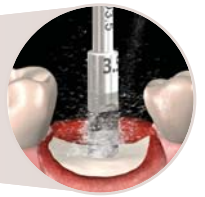

Surgical Drills

15

16

SwishPlant Surgical Tray

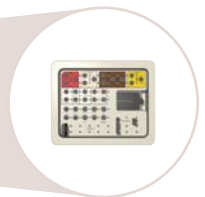

Insertion Instruments and
Prosthetic Tools

17



SwishPlant Fixture-Mount Packaging

SwishPlant Implants are mounted on color-coded fixture-mounts, designed for use as implant level transfers or shortened to function as straight abutments. A cover screw and implant extender is included in each vial. The SwishPlant fixture-mount is provided with a snap-on comfort cap.

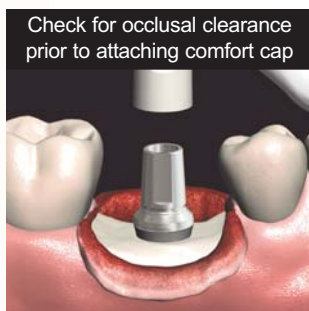
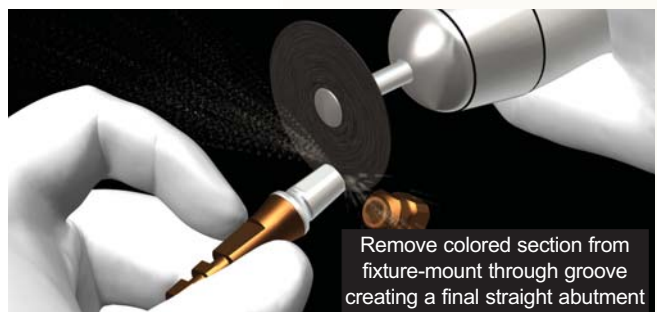
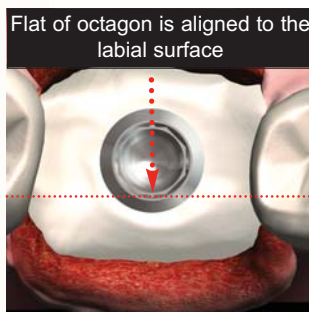
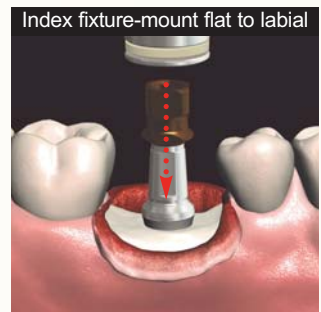
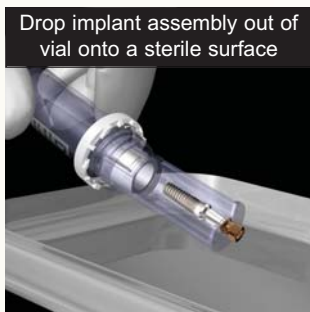



Mini-threads with Double-lead Threads for Faster Insertion

The SwishPlant implant surface is textured using SBM (HA crystal Soluble Blast Media) to create a 2mmL cylindrical neck region with an Ra value of 0.5μ (light texture) and a threaded body with an Ra value of 1.5μ (medium texture). Starting at the junction between the two surface textures, the threaded body has a 2.0mmL straight section below which then tapers 1.5 degrees to a round apex. This gentle taper facilitates insertion into an undersized socket in soft bone providing compression that increases initial stability (*G. Niznick: Clinical Oral Health 2000 "Achieving Success in Soft Bone"*) and the percentage of bone attachment (**Shabali MM: Clin Oral Impl Res 2006). Mini-threads start 0.5mm below the textured dividing line and extend approximately 2.0mm before transitioning into double-lead buttress threads that get progressively deeper toward the apex of the implant. The Mini-threads, half the depth and pitch of the double-lead body threads, reduce stress in the critical crestal bone region, while double-lead threads reduce the number of turns required to seat the implant. Vertical cutting grooves extend halfway up the implant from the apex for self-tapping insertion.

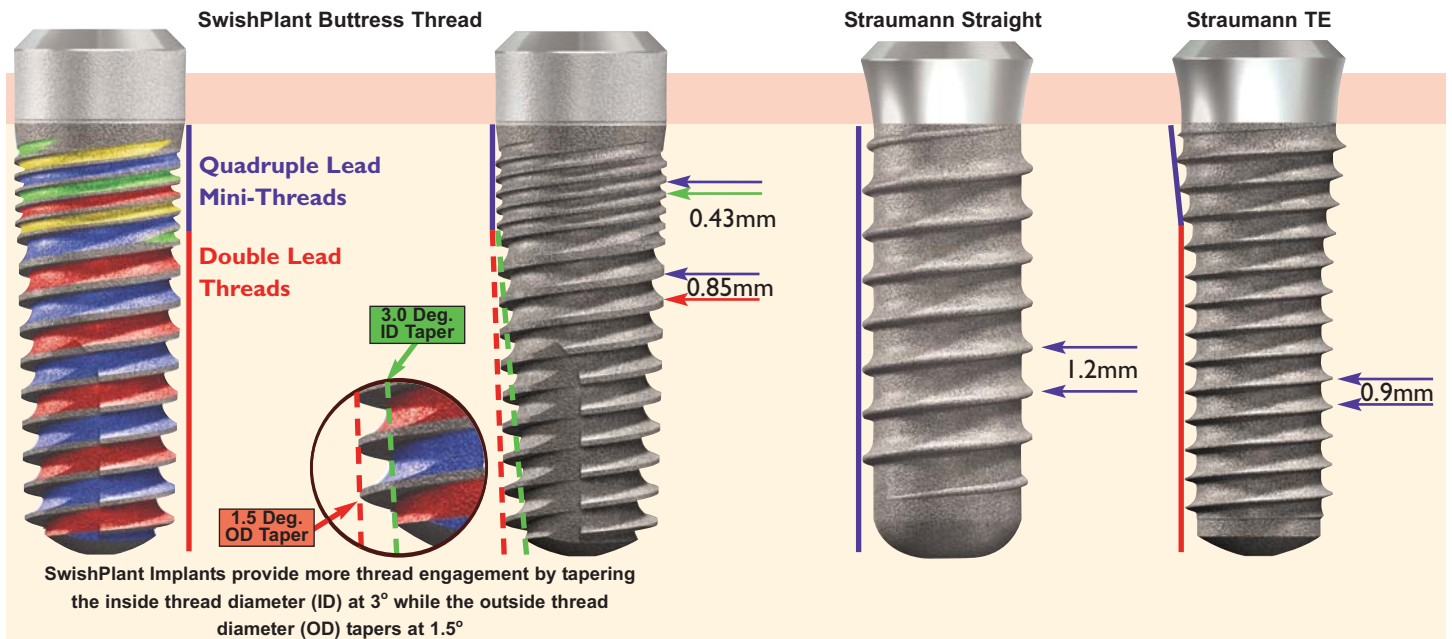

Dual Blast SBM Surface: A 20 Year History of Clinical Success

The implant is available with variable SBM textured surface over the entire implant, excluding the machined prosthetic interface. **SBM** surface is created by using a **S**oluble **B**last **M**edia of Hydroxylapatite (HA) crystals to create a medium-rough and a lightly textured transmucosal section, without rounding of threads. Implant Direct uses the same vendor for its SBM and HA surface treatments as used by Paragon Implant Company from 1992-2000 when these studies were conducted.

SEM's of Implant Direct's Surfaces

Surface textured by blasting with variable size soluble HA Particles to create a **Dual Blast SBM** surface on the body (rough) and transmucosal (light) portion of implant.

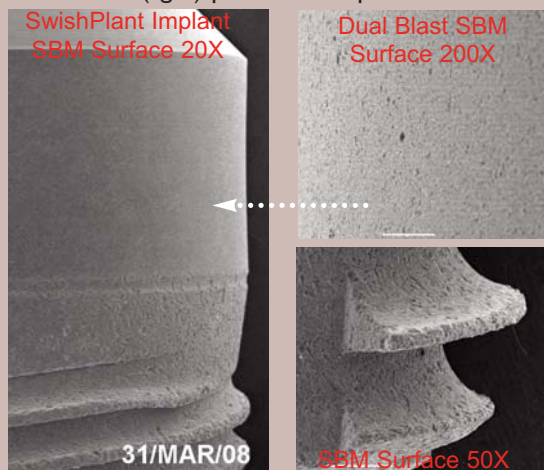

Animal Studies Bone Response to SBM Surface

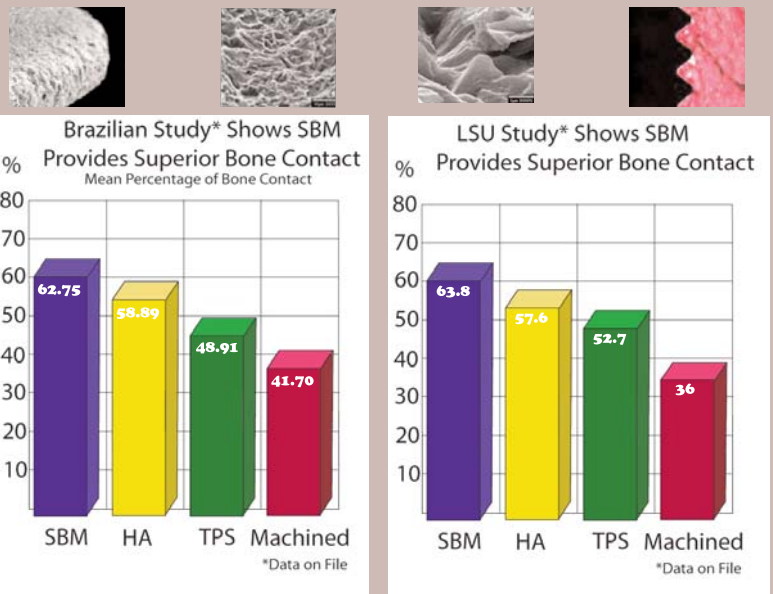



Implant Design & Dimensions

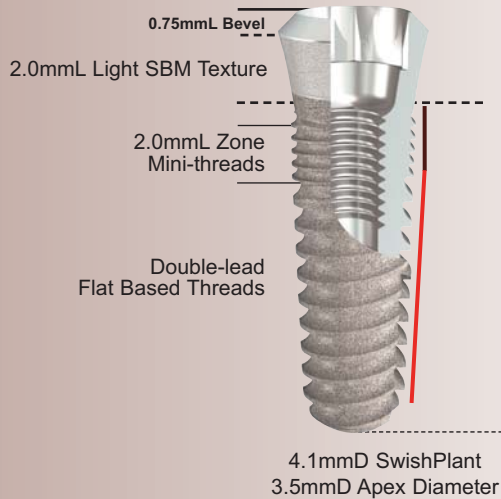
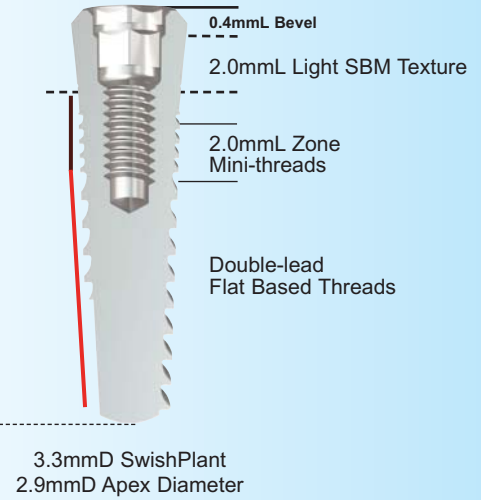
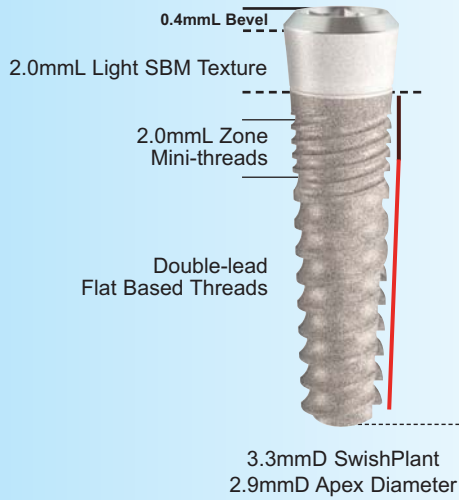

Straumann Compatible
4.8mmD Platform with a
3.0mmD Internal Octagon
**Plus internal square for
Fixture-mount engagement**

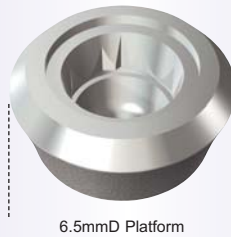
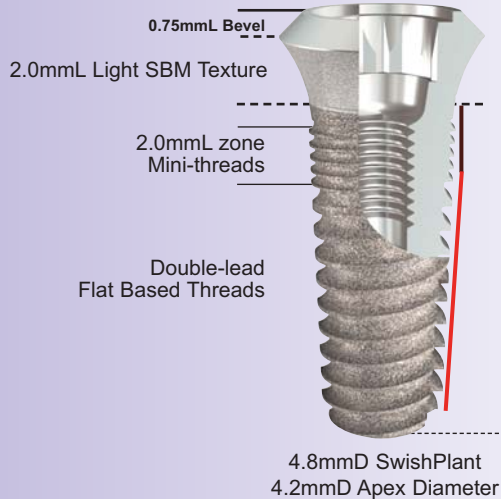
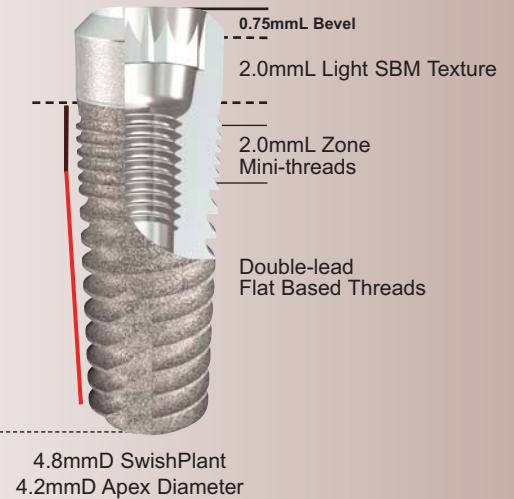

Straumann Compatible
6.5mmD Platform with a
3.0mmD Internal Octagon
**Plus internal square for
Fixture-mount engagement**

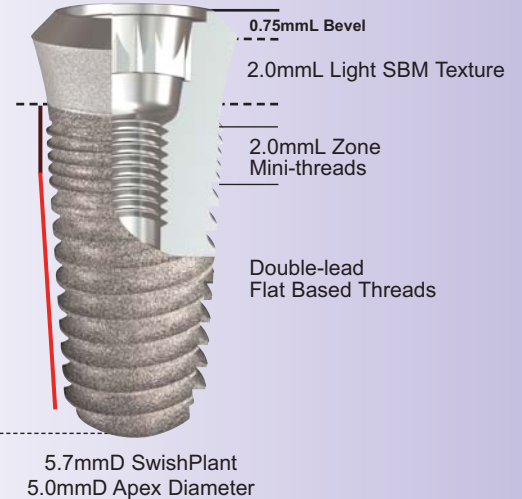

SwishPlant Implant System Features and Benefits

- Straumann compatible 4.8 and 6.5mmD platforms with wrench-engaging internal square for engagement of Fixture-mount
- Implant dimensions designed to allow insertion in soft bone using Straumann drills
- Dual texture SBM (Soluble Blast Media): Rough on implant body and light blast on neck, allows for Tissue- and Bone-level insertion
- Tapered body with progressively deeper, flat based threads provide greater surface area and primary stability
- Self-tapping insertion: Vertical cutting grooves
- Double-lead body threads for faster insertion and quadruple-lead mini-threads for reduced stress concentration *
- All-in-one packaging includes Cover Screw, 2mm Healing Collar and Transfer
- Color-coded Fixture-mount/Transfer, shortened for use as a Straight Abutment with snap-on Comfort Cap

3.7mmD Platform



4.8mmD Platform



4.8mmD Platform



6.5mmD Platform



6.5mmD Platform



3.3mmD Implant



4.1mmD Implant



4.8mmD Implant



4.8mmD Implant



5.7mmD Implant



SwishPlant Packaging

4.8mmD Platform
904112
12mm Length

Carrier/Transfer

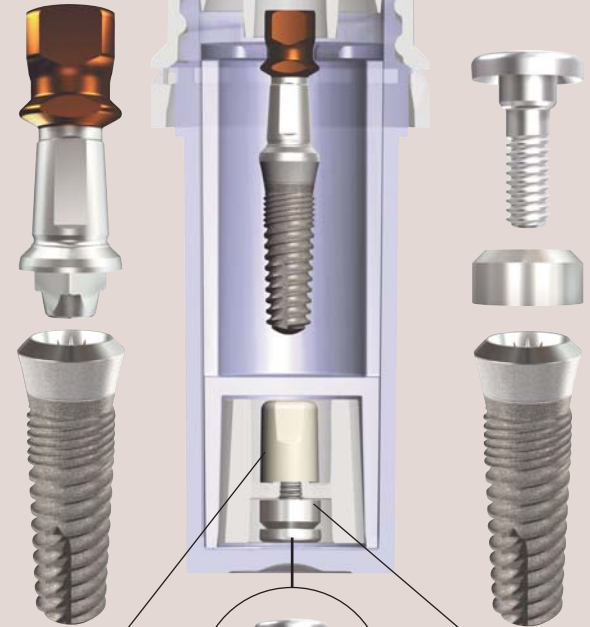

Comfort Cap



Cover Screw



Extender

One-Stage Implant Placement Options

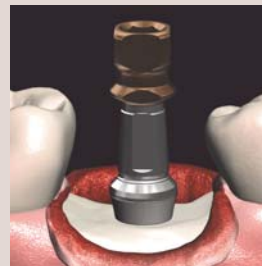

Tissue-level placement

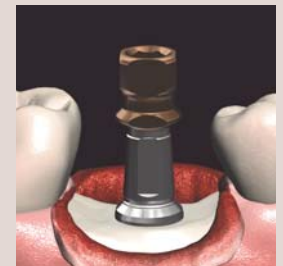

Bone-level placement



Cover Screw on Implant

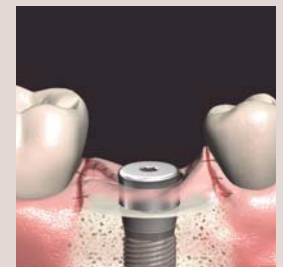

Cover Screw & 2mm Extender on Implant



SBM Dual Blast Surface Implants Includes Cover Screw, Extender & Carrier / Transfer

3.3mmD

Code	Diameter	Length	Platform	Price
903308	3.3mmD	8mmL	3.7mmD	\$200.00
903310	3.3mmD	10mmL	3.7mmD	\$200.00
903312	3.3mmD	12mmL	3.7mmD	\$200.00
903314	3.3mmD	14mmL	3.7mmD	\$200.00
903316	3.3mmD	16mmL	3.7mmD	\$200.00



4.1mmD

Code	Diameter	Length	Platform	Price
904106	4.1mmD	6mmL	4.8mmD	\$200.00
904108	4.1mmD	8mmL	4.8mmD	\$200.00
904110	4.1mmD	10mmL	4.8mmD	\$200.00
904112	4.1mmD	12mmL	4.8mmD	\$200.00
904114	4.1mmD	14mmL	4.8mmD	\$200.00
904116	4.1mmD	16mmL	4.8mmD	\$200.00



4.8mmD

Code	Diameter	Length	Platform	Price
904806	4.8mmD	6mmL	4.8mmD	\$200.00
904808	4.8mmD	8mmL	4.8mmD	\$200.00
904810	4.8mmD	10mmL	4.8mmD	\$200.00
904812	4.8mmD	12mmL	4.8mmD	\$200.00
904814	4.8mmD	14mmL	4.8mmD	\$200.00



4.8mmD

Code	Diameter	Length	Platform	Price
904806W	4.8mmD	6mmL	6.5mmD	\$200.00
904808W	4.8mmD	8mmL	6.5mmD	\$200.00
904810W	4.8mmD	10mmL	6.5mmD	\$200.00
904812W	4.8mmD	12mmL	6.5mmD	\$200.00
904814W	4.8mmD	14mmL	6.5mmD	\$200.00













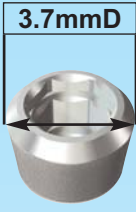
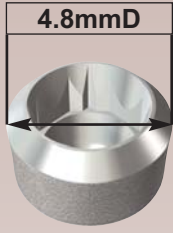
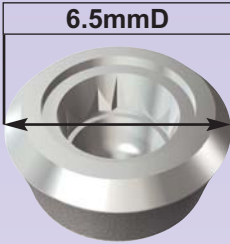































5.7mmD

Code	Diameter	Length	Platform	Price
905706	5.7mmD	6mmL	6.5mmD	\$200.00
905708	5.7mmD	8mmL	6.5mmD	\$200.00
905710	5.7mmD	10mmL	6.5mmD	\$200.00
905712	5.7mmD	12mmL	6.5mmD	\$200.00
905714	5.7mmD	14mmL	6.5mmD	\$200.00





Selection Chart: Straight Abutments (Snap-On), Transfers & Analogs

3.7mmD Platform		4.8mmD Platform		6.5mmD Platform			
							
  Implant Transfer closed-tray 9037-05 open-tray 9037-08 Fixture-mount/Transfer		  Implant Transfer closed-tray 9048-05N open-tray 9048-08N Fixture-mount/Transfer		  Implant Transfer closed-tray 9048-05 open-tray 9048-08 Flared 4.8 to 5.7 Fixture-mount/Transfer		  Implant Transfer closed-tray 9065-05 open-tray 9065-08 Fixture-mount/Transfer	
 Implant Analog 9037-06		 Implant Analog 9048-06		 Implant Analog 9048-06		 Implant Analog 9065-06	
Straight Abutment Covered bevel narrow profile  Exposed bevel platform switching  9037-21 8530-21 OR 		Straight Abutments Covered bevel narrow profile  Exposed bevel 2-piece Abutment  1-piece Solid Abutment  9048-21N 9048-20 9048-20-1 OR 		Straight Abutments with Flared Collars 4.8 to 5.7 Covered bevel   9048-21 9048-22 0.5mL cuff 2mL cuff		Straight Abutments Exposed bevel 2-piece Abutment  1-piece Solid Abutment  9065-20 9065-20-1 OR 	
 Straight Abutment Transfer 9037-02		 Straight Abutment Transfer 9047-02		 Straight Abutment Transfer 3057-02		 Straight Abutment Transfer 3065-02	
  Comfort Cap 3037-26 Castable Coping 3037-28		  Comfort Cap 3047-26 Castable Coping 3047-28		  Comfort Cap 3057-26 Castable Coping 3057-28		  Comfort Cap 3065-26 Castable Coping 3065-28	
Straight Abutment Analog 9037 incl. Castable Coping  		Straight Abutment Analog 9047 incl. Castable Coping  		Straight Abutment Analog 3057 incl. Castable Coping  		Straight Abutment Analog 3065 incl. Castable Coping  	



Straight Abutments, Snap-on Transfers and Lab Analogs

Straight Abutments

Includes Transfer, Comfort Cap & Fixation Screw with 1.25mmD Hex
 "PS" for Platform Switching Interface

Code	Platform	Collar Heights	Use Analog	Price
8530-21	3.7mmD PS	1.0mm	3037	\$85.00
8530-22	3.7mmD PS	2.0mm	3037	\$85.00
8530-23	3.7mmD PS	3.0mm	3037	\$85.00
9037-21	3.7mmD	0.5mm	3037	\$85.00
9037-22	3.7mmD	2.0mm	3037	\$85.00
9048-21N	4.8mmD	0.5mm	9047	\$85.00
9048-22N	4.8mmD	2.0mm	9047	\$85.00
9048-21	4.8mmD	0.5mm	3057	\$85.00
9048-22	4.8mmD	2.0mm	3057	\$85.00

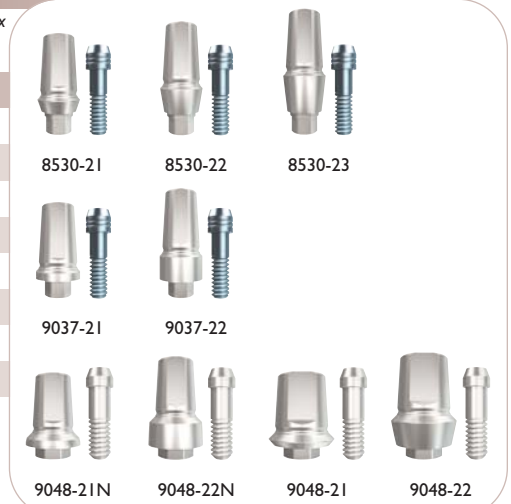

Straight Abutments - Exposed Bevel

Includes Transfer, Comfort Cap & Fixation Screw with 1.25mmD Hex

Code	Platform	Use Analog	Abutment Kit	Price
9048-20	4.8mmD	9047		\$85.00
9048-20-1	4.8mmD		Includes Analog 9047	\$100.00
9065-20	6.5mmD	3065		\$85.00
9065-20-1	6.5mmD		Includes Analog 3065	\$100.00



Straight Abutment Transfers

Code	Abutment Width	Price (includes two pieces)
9037-02	3.7mmD	\$30.00
9047-02	4.7mmD	\$30.00
3057-02	5.7mmD	\$30.00
3065-02	6.5mmD	\$30.00



Straight Abutment Comfort Caps

Code	Abutment Width	Price (includes two pieces)
3037-26	3.7mmD	\$30.00
3047-26	4.7mmD	\$30.00
3057-26	5.7mmD	\$30.00
3065-26	6.5mmD	\$30.00

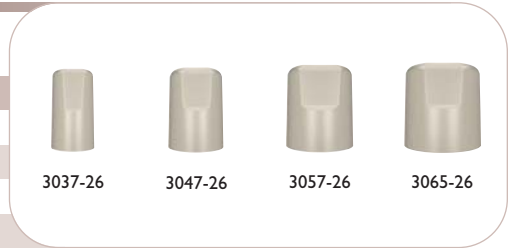

Straight Abutment Analogs

Includes Castable Coping

Code	Abutment Width	Price
9037	3.7mmD	\$35.00
9047	4.7mmD	\$35.00
3057	5.7mmD	\$35.00
3065	6.5mmD	\$35.00



Straight Abutment Castable Coping

Code	Abutment Width	Price (includes two pieces)
3037-28	3.7mmD	\$30.00
3047-28	4.7mmD	\$30.00
3057-28	5.7mmD	\$30.00
3065-28	6.5mmD	\$30.00

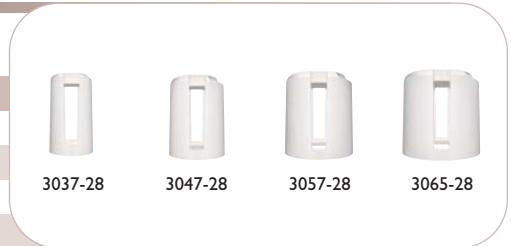



Selection Chart: Abutments for Cemented Restorations

3.7mmD Platform

3.7mmD

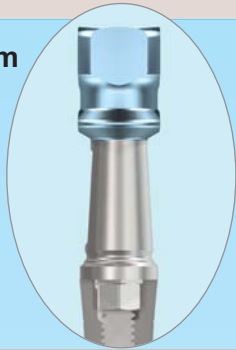
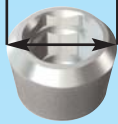

4.8mmD Platform

4.8mmD

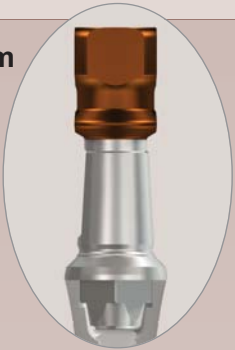
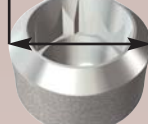

6.5mmD Platform

6.5mmD

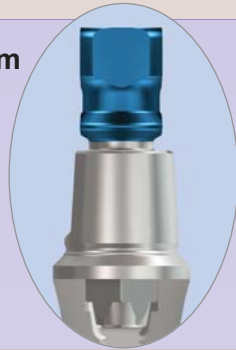
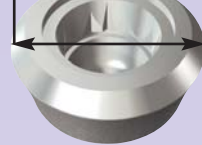

Narrow Straight Abutment with Bevel Covered

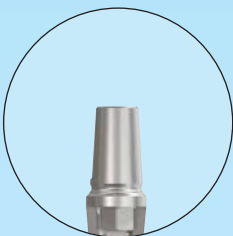

0.5mm Collar
9037-21
2mm = 9037-22

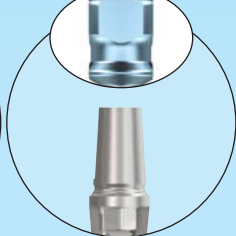

Shorten
Fixture-mount
duplicates 9037-21



0.5mm Collar
9048-21N
2mm = 9048-22N

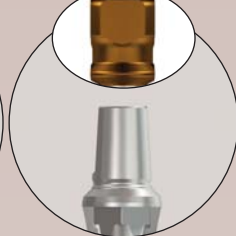

Shorten
Fixture-mount
duplicates 9048-21N

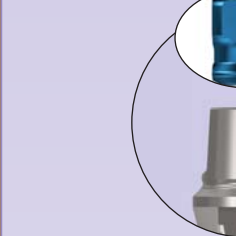

Shorten
Fixture-mount
for 1.0mm Collar

Narrow Straight Abutment with Bevel Exposed



2-Piece Hex
Engaging Abutment
8530-21



2-Piece Octagon
Engaging Abutment
9048-20

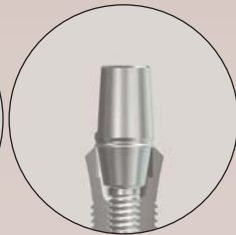

1-Piece Solid
Abutment
9048-20-1

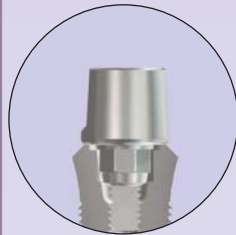

2-Piece Octagon
Engaging Abutment
9065-20

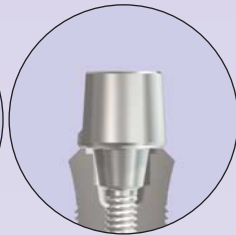

1-Piece Solid
Abutment
9065-20-1

Straight and Angled Platform Switching Abutments with Contoured Margins

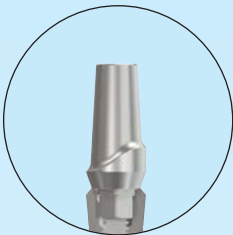

1mm Collar
8530-31
2mm = 8530-32



0.75mm Collar
8530-51
2mm = 8530-52



0.75mm Collar
9048-31P

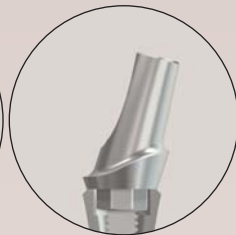

0.75mm Collar
9048-51P

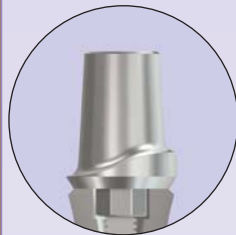

0.75mm Collar
9065-31P

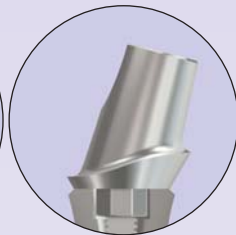

0.75mm Collar
9065-51P

4.8mmD Platform Straight and Angled Abutments with Flared Collars



Straight Snap-on
Abutment
0.5mm Collar
9048-21



Straight Snap-on
Abutment
2mm Collar
9048-22



Straight Contoured
Abutment
0.5mm Collar
9048-31



Straight Contoured
Abutment
2mm Collar
9048-32



Angled Contoured
Abutment
0.5mm Collar
9048-51



Angled Contoured
Abutment
2mm Collar
9048-52



Gold, Plastic and Titanium Engaging and Non-Engaging Abutments

Gold Engaging Cast-to Abutments

Price includes Fixation Screw with 1.25mmD Hex
 "PS" for Platform Switching Interface

Code	Platform	Collar Heights	Replacement Screw	Price
8530-40	3.7mmD PS	1.0mm	1000-04	\$100.00
9048-40	4.8mmD	1.0mm	1000-16	\$100.00



Gold Non-Engaging Cast-to Abutments

Price includes Fixation Screw with 1.25mmD Hex

Code	Platform	Collar Heights	Replacement Screw	Price
8530-41	3.7mmD PS	1.0mm	1000-04	\$100.00
9048-41	4.8mmD	1.0mm	1000-16	\$100.00



Plastic Non-Engaging Castable Abutments

Price includes Fixation Screw with 1.25mmD Hex

Code	Platform	Collar Heights	Replacement Screw	Price
8530-46	3.7mmD PS	1.0mm	1000-04	\$30.00
9048-46	4.8mmD	1.0mm	1000-16	\$30.00
9065-46	6.5mmD	1.0mm	1000-16	\$30.00



Plastic Engaging Temporary Abutments

Price includes Fixation Screw with 1.25mmD Hex

Code	Platform	Collar Heights	Replacement Screw	Price
8530-47	3.7mmD PS	1.0mm	1000-09	\$35.00
9048-47	4.8mmD	1.0mm	1000-17	\$35.00
9065-47	6.5mmD	1.0mm	1000-17	\$35.00



Titanium Non-Engaging Temporary Abutments

Price includes Fixation Screw with 1.25mmD Hex

Code	Platform	Collar Heights	Replacement Screw	Price
8530-49	3.7mmD PS	1.0mm	1000-04	\$35.00
9048-49	4.8mmD	1.0mm	1000-16	\$35.00
9065-49	6.5mmD	1.0mm	1000-16	\$35.00



Straight Contoured Abutments

Price includes Fixation Screw with 1.25mmD Hex

Code	Platform	Collar Heights	Replacement Screw	Price
8530-31	3.7mmD PS	1.0 mm	1000-04	\$85.00
8530-32	3.7mmD PS	2.0 mm	1000-04	\$85.00
9048-31	4.8mmD	0.5 mm	1000-16	\$85.00
9048-32	4.8mmD	2.0 mm	1000-16	\$85.00
9048-31P	4.8mmD PS	0.75mm	1000-16	\$85.00
9065-31P	6.5mmD PS	0.75mm	1000-16	\$85.00



Angled Contoured Abutments

Price includes Fixation Screw with 1.25mmD Hex

Code	Platform	Collar Heights	Replacement Screw	Price
8530-51	3.7mmD PS	0.75mm	1000-04	\$85.00
8530-52	3.7mmD PS	2.0 mm	1000-04	\$85.00
9048-51	4.8mmD	0.5 mm	1000-16	\$85.00
9048-52	4.8mmD	2.0 mm	1000-16	\$85.00
9048-51P	4.8mmD PS	0.75mm	1000-16	\$85.00
9065-51P	6.5mmD PS	0.75mm	1000-16	\$85.00





Selection Chart: Overdenture & Screw-Retained Restorations

3.7mmD Platform

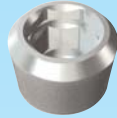

4.8mmD Platform

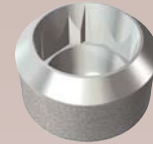

Overdenture Abutments (*Includes Transfer and Comfort Cap)

Overdenture Abutments



9037-61



9037-62



9037-63



9048-61



9048-62



9048-63



9048-64

Overdenture Abutment Transfer, Analog & Comfort Cap

OD Abutment Comfort Cap Transfer and Analogs



*4000-13



*1000-68



1000-61



Open-Tray Transfer

1000-62



Closed-Tray Transfer

1000-63

Overdenture Copings

Overdenture Abutment Components



1000-64

Gold



1000-65

Titanium



1000-66

Plastic



1000-67

Gold/Plastic



1000-69

Titanium

Ball Abutments (**Includes Transfer and Comfort Cap)

Ball Abutments



9037-71



9037-72



9037-73



9048-71



9048-72



9048-73

Ball Attachments

Ball Abutment Components



**1000-87



**1000-84



1000-85



1000-81



1000-82



1000-88



1000-83



1000-86

Locator® Abutments

Locator® Abutments



9037-91



9037-92



9037-93



9048-91



9048-92



9048-93

Locator® Attachments

Locator® Abutment Components



1000-94



1000-95



1000-92B



1000-92C



1000-92G



1000-92P



1000-92R



1000-98



1000-93



1000-96



Prosthetic Components for Overdenture & Screw-Retained Restorations

Overdenture Abutments

Includes Transfer & Comfort Cap - requires 1.25mmD Hex Tool

Code	Platform	Collar Heights	Price
9037-61	3.7mmD	1mm	\$85.00
9037-62	3.7mmD	2mm	\$85.00
9037-63	3.7mmD	3mm	\$85.00
9048-61	4.8mmD	1mm	\$85.00
9048-62	4.8mmD	2mm	\$85.00
9048-63	4.8mmD	3mm	\$85.00
9048-64	4.8mmD	4mm	\$85.00

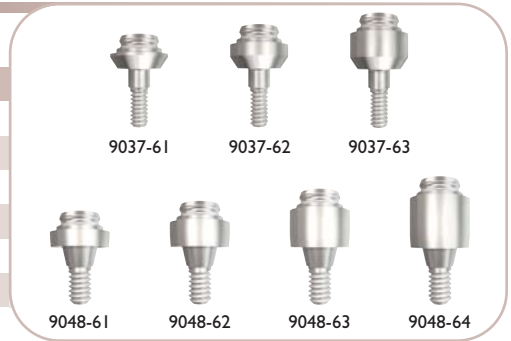

Ball Abutments

Includes Transfer & Comfort Cap - requires 1.25mmD Hex Tool

Code	Platform	Collar Heights	Price
9037-71	3.7mmD	1mm	\$85.00
9037-72	3.7mmD	2mm	\$85.00
9037-73	3.7mmD	3mm	\$85.00
9048-71	4.8mmD	1mm	\$85.00
9048-72	4.8mmD	2mm	\$85.00
9048-73	4.8mmD	3mm	\$85.00

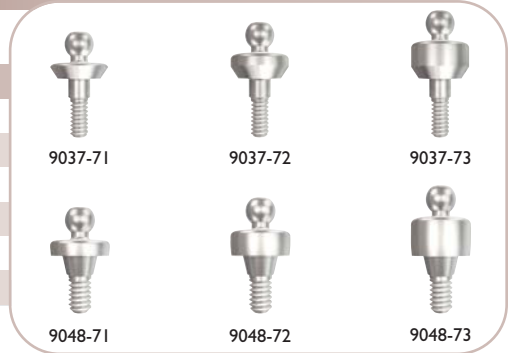

Overdenture Abutment Comfort Cap, Transfers & Analog

Screws require 1.25mmD Hex Tool

Code	Prosthetic Platform	Description	Price
1000-61	5.0mmD	Aluminum Analog	\$20.00
1000-62	5.0mmD	Open-Tray Transfer plus Fixation Screw	\$30.00
1000-63	5.0mmD	Closed-Tray Transfer plus Fixation Screw	\$30.00
1000-68	5.0mmD	Plastic Abutment Transfer - 2ea	\$30.00
4000-13	5.0mmD	Plastic Comfort Cap - 2ea	\$30.00
1000-14	-	Replacement Open-Tray Fixation Screw - 2ea	\$30.00
1000-15	-	Replacement Closed-Tray Fixation Screw - 2ea	\$30.00

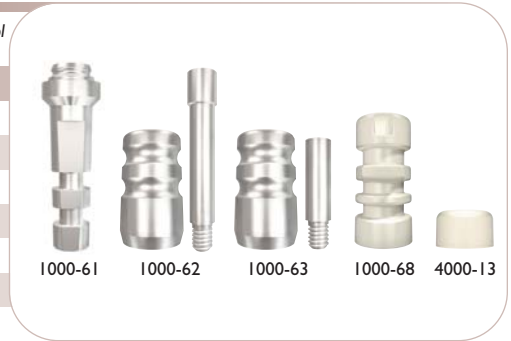

Overdenture Abutment Components

Price includes Fixation Screw [1000-05] with 1.25mmD Hex

Code	Prosthetic Platform	Description	Price
1000-05	-	Coping Replacement Fixation Screw - 2ea	\$30.00
1000-64	5.0mmD	Gold Coping	\$75.00
1000-65	5.0mmD	Titanium Coping	\$40.00
1000-66	5.0mmD	Plastic Coping	\$35.00
1000-67	5.0mmD	Gold & Plastic Coping	\$75.00
1000-69	5.0mmD	Titanium Temporary Coping	\$35.00



Ball Abutment Components

Code	Description	Price
1000-81	Ball Abutment Housing - 2ea	\$30.00
1000-82	Nylon Liner - 2ea	\$15.00
1000-83	Nylon Liner Transfers - 2ea	\$15.00
1000-84	Ball Abutment Transfer - 2ea	\$30.00
1000-85	Ball Abutment Analog	\$20.00
1000-86	Ball Abutment Tools	\$65.00
1000-87	Ball Abutment Comfort Cap - 2ea	\$30.00
1000-88	Ball Abutment Housing & Nylon Liner	\$22.00

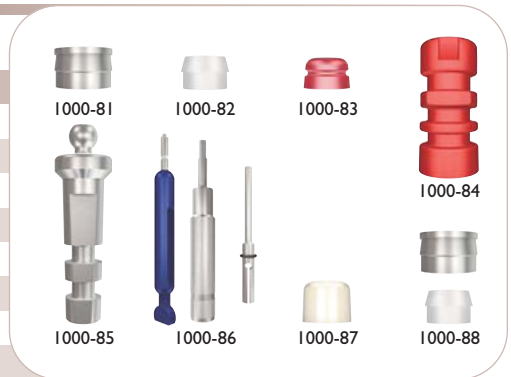



Locator® Abutments, Prosthetic Components & Ancillary Products

SwishPlant Locator® Abutments

Requires purchase of Abutment Processing Cap/Male Kit [1000-98]

Code	Platform	Collar Heights	Price
9037-91	3.7mmD	1mm	\$110.00
9037-92	3.7mmD	2mm	\$110.00
9037-93	3.7mmD	3mm	\$110.00
9048-91	4.8mmD	1mm	\$110.00
9048-92	4.8mmD	2mm	\$110.00
9048-93	4.8mmD	3mm	\$110.00

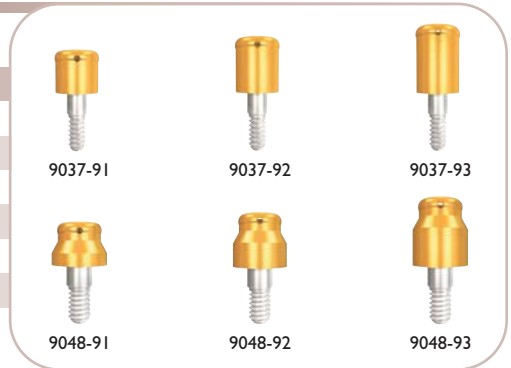

Locator® Abutment Transfer, Analogs and Alignment Tools

Code	Description	Price
1000-94	Locator® Impression Coping - 2ea	\$32.00
1000-95	Locator® Abutment Analog 4mmD - 2ea	\$32.00
1000-95W	Locator® Abutment Analog 5mmD - 2ea	\$32.00
1000-97	Locator® Abutment Parallel Post - 4ea	\$16.00
1000-18	Guide Screw for SwishPlant 4.8mmD Platform - 2ea	\$30.00
1000-99	Locator® Abutment Angle Measure Guide	\$21.00



Locator® Abutment Components

Code	Retention Force	Description	Price
1000-92C	5.0lbs	Replacement Male Clear - 4ea	\$21.00
1000-92P	3.0lbs	Light Replacement Male Pink - 4ea	\$21.00
1000-92B	1.5lbs	Extra Light Replacement Male Blue - 4ea	\$21.00
1000-92G	4.0lbs	Extended Range Male Green - 4ea	\$21.00
1000-92R	1.0lb	Extra Light Extended Range Male Red - 4ea	\$21.00
1000-93	-	Black Processing Male - 4ea	\$21.00
1000-98	Assorted	Abutment Processing Cap/Male Kit - 2ea	\$58.00



Locator® Instrumentation

Code	Description	Price
LDT	Locator® Abutment Driver Tool - Long	\$44.00
LDS	Locator® Abutment Driver Tool - Short	\$44.00
LDD	Locator® Abutment Driver Drill - Long	\$44.00
LDSD	Locator® Abutment Driver Drill - Short	\$44.00
1000-96	Core Tool - Male Removal & Seating Tool and Abutment Driver	\$75.00

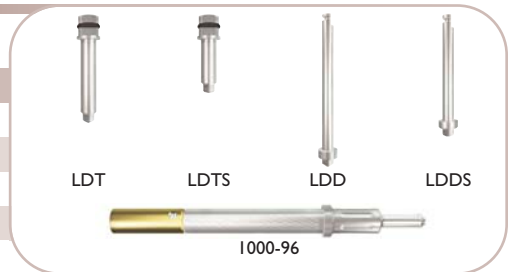



Cover Screws, Healing Collars, Transfers & Analogs

Surgical Cover Screws

* Only for use with SwishPlant Implants - use 1.25mmD Hex Tool
 * Can be used with Straumann Insertion Tool

Code	Platform	Price
9037-01	* 3.7mmD	\$20.00
9048-01	* 4.8mmD	\$20.00
9065-01	* 6.5mmD	\$20.00
9048-01S	* 4.8mmD	\$20.00
9065-01S	* 6.5mmD	\$20.00



Healing Collars

Requires 1.25mmD Hex Tool
 "PS" for Platform Switching Interface

Code	Platform	Width	Length	Price
8530-13	3.7mmD PS	3.7mmD	3mmL	\$30.00
8530-15	3.7mmD PS	3.7mmD	5mmL	\$30.00
9037-12	3.7mmD	3.7mmD	2mmL	\$30.00
9037-13	3.7mmD	3.7mmD	3mmL	\$30.00
9048-12N	4.8mmD	5.1mmD	2mmL	\$30.00
9048-13N	4.8mmD	5.1mmD	3mmL	\$30.00
9048-12	4.8mmD	5.8mmD	2mmL	\$30.00
9048-13	4.8mmD	5.8mmD	3mmL	\$30.00
9065-12	6.5mmD	6.5mmD	2mmL	\$30.00
9065-13	6.5mmD	6.5mmD	3mmL	\$30.00



Closed-Tray Implant Transfers

Price includes Fixation Screw with 1.25mmD Hex

Code	Platform	Replacement Screw	Price
9037-05	3.7mmD	1000-09	\$30.00
9048-05N	4.8mmD	1000-17	\$30.00
9048-05	4.8mmD	1000-17	\$30.00
9065-05	6.5mmD	1000-17	\$30.00



Open-Tray Implant Transfers

Price includes Fixation Screw with 1.25mmD Hex

Code	Platform	Replacement Screw	Price
9037-08	3.7mmD	1000-26	\$30.00
9048-08N	4.8mmD	1000-18	\$30.00
9048-08	4.8mmD	1000-18	\$30.00
9065-08	6.5mmD	1000-18	\$30.00



Implant Analogs

Code	Platform	Price
9037-06	3.7mmD	\$20.00
9048-06	4.8mmD	\$20.00
9065-06	6.5mmD	\$20.00



Replacement Fixation Screws

Requires 1.25mmD Hex Tool

Code	Description	Price (includes two pieces)
1000-04	For use with 3.7 hexagon platform	\$30.00
1000-09	For use with 3.7 hexagon platform	\$30.00
1000-26	For use with 3.7 hexagon platform	\$30.00
1000-16	For use with 4.8 & 6.5mmD octagon platforms	\$30.00
1000-17	For use with 4.8 & 6.5mmD octagon platforms	\$30.00
1000-18	For use with 4.8 & 6.5mmD octagon platforms	\$30.00





SwishPlant Drill Sequence

3.3mmD Straight / Tapered Implant

3.3/3.7



2.3mmD Drill



SOFT BONE
3.3mmD Implant

DENSE BONE
3.3mmD Implant



SPD2.8

Use SPD2.8 Drill as final step for Tissue-level or Bone-level placement
Crestal bone in Maxilla will expand without countersink



Tissue Level FINAL DRILL SPCD3.3 3.3mmD/3.7mmD



Bone Level FINAL DRILL SPCD3.3 3.3mmD/3.7mmD

4.1mmD Straight / Tapered Implant

4.1/4.8



2.3mmD Drill



SOFT BONE
4.1mmD Implant

DENSE BONE
4.1mmD Implant



SPD2.8



SPD3.5

Use SPD3.5 Drill as final step for Tissue-level or Bone-level placement
Crestal bone in Maxilla will expand without countersink



Tissue Level FINAL DRILL SPCD4.1 4.1mmD/4.8mmD



Bone Level FINAL DRILL SPCD4.1 4.1mmD/4.8mmD

4.8mmD Straight / Tapered Implant

4.8/4.8

4.8/6.5



2.3mmD Drill



SOFT BONE
4.8mmD Implant

DENSE BONE
4.8mmD Implant



SPD2.8



SPD3.5



SPD4.2

Use SPD4.2 Drill as final step for Tissue-level or Bone-level placement
Crestal bone in Maxilla will expand without countersink

Use SPD4.2 Drill as final step for Tissue-level placement.
Crestal bone in Maxilla will partially expand to allow 1mm subcrestal seating of neck.



Tissue Level FINAL DRILL SPCD4.8 4.8mmD/4.8mmD



Bone Level FINAL DRILL SPCD4.8 4.8mmD/4.8mmD



Tissue Level FINAL DRILL SPCD4-6 4.8mmD/6.5mmD



Bone Level FINAL DRILL SPCD4-6 4.8mmD/6.5mmD

5.7mmD Straight / Tapered Implant

5.7/6.5



2.3mmD Drill



SOFT BONE
5.7mmD Implant

DENSE BONE
5.7mmD Implant



SPD2.8



SPD3.5



SPD4.2



SPD5.1

Use SPD5.1 Drill as final step for Tissue-level or Bone-level placement
Crestal bone in Maxilla will expand without countersink



Tissue Level FINAL DRILL SPCD5-6 5.7mmD/6.5mmD



Bone Level FINAL DRILL SPCD5-6 5.7mmD/6.5mmD



Surgical Drills: SwishPlant System Implants

Pilot Drills

Code	Description	Price
SPD2.3	2.3mmD Straight Drill with 6-16 markings	\$60.00
SD2.3S	2.3/2.0mmD Step Drill with 6-10 markings	\$60.00



3.3mmD Implants

Code	Description	Price
SPD2.8	2.8mmD Straight Drill with 6-16 markings	\$60.00
SD2.8S	2.8/2.3mmD Step Drill with 6-10 markings	\$60.00
SPCD3.3	3.3/3.7mmD SwishPlant Countersink Drill	\$60.00



4.1mmD Implants

Code	Description	Price
SPD3.5	3.5mmD Straight Drill with 6-16 markings	\$60.00
SPD3.5S	3.5mmD Straight Drill with 6-10 markings	\$60.00
SPCD4.1	4.1/4.8mmD SwishPlant Countersink Drill	\$60.00



4.8mmD Implants

Code	Description	Price
SPD4.2	4.2mmD Straight Drill with 6-16 markings	\$60.00
SPD4.2S	4.2mmD Straight Drill with 6-10 markings	\$60.00
SPCD4.8	4.8/4.8mmD SwishPlant Countersink Drill	\$60.00
SPCD4-6	4.8/6.5mmD SwishPlant Countersink Drill	\$60.00



5.7mmD Implants

Code	Description	Price
SPD5.1	5.1mmD Straight Drill with 6-16 markings	\$60.00
D5.1S	5.1mmD Straight Drill with 6-10 markings	\$60.00
SPCD5-6	5.7/6.5mmD SwishPlant Countersink Drill	\$60.00





Complete SwishPlant Surgical Tray Contents

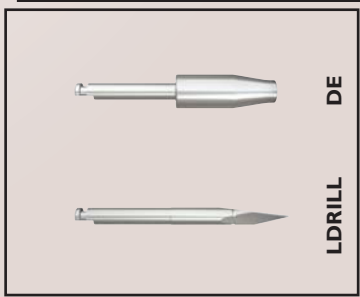
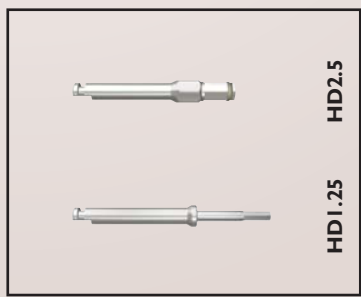
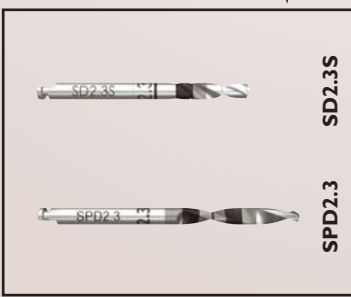
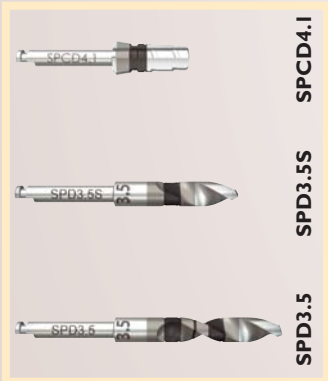
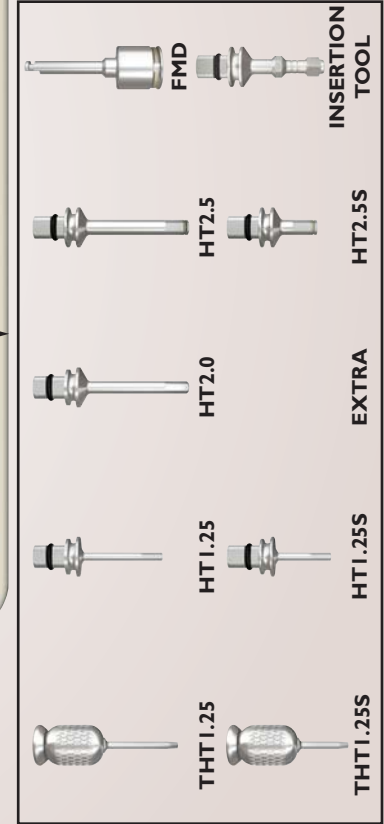
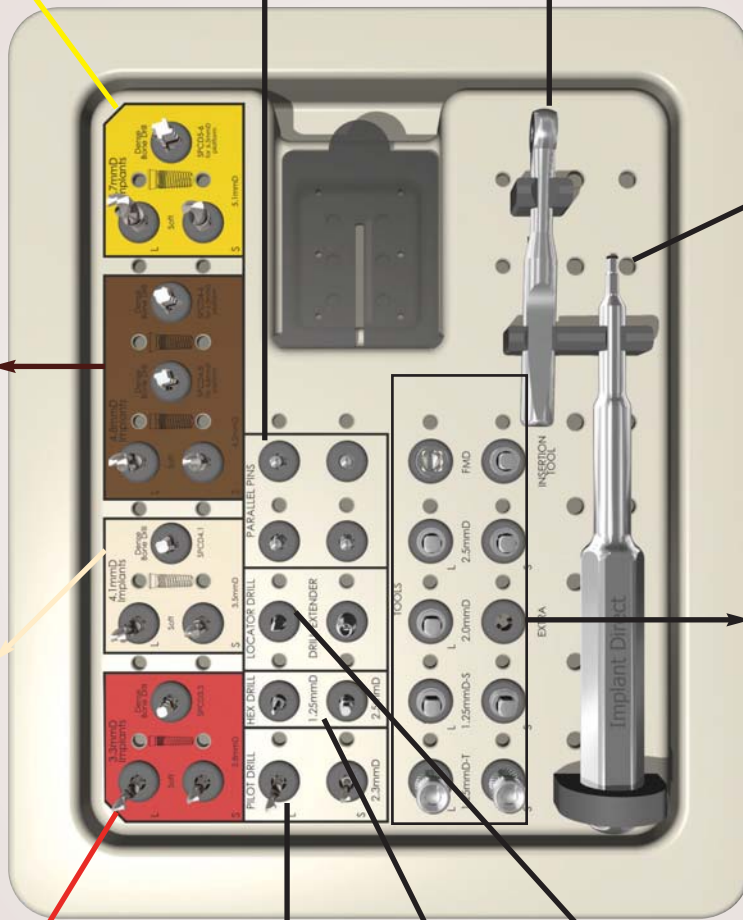
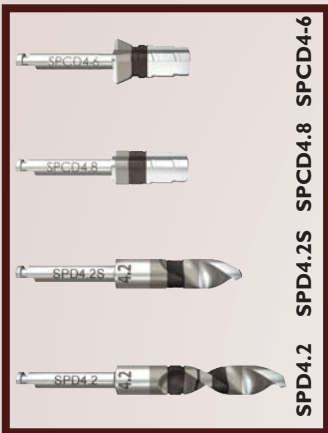
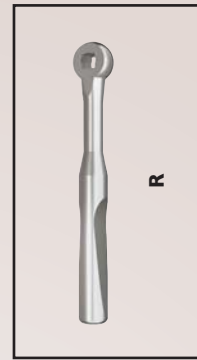
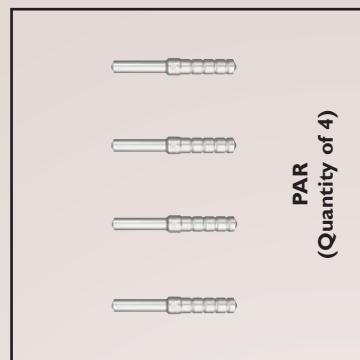
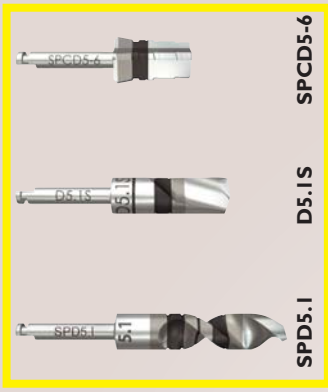



Surgical and Prosthetic Instruments

Tapered Hex Tools

Code	Description	Price
THT1.25	1.25mmD Tapered Hex Tool Long	\$40.00
THT1.25S	1.25mmD Tapered Hex Tool Short	\$40.00



THT1.25



THT1.25S

Straight Tools

Square connection for use with Ratchet or Torque Wrench

Code	Description	Price
HT1.25	1.25mmD Straight Hex Tool Long	\$40.00
HT1.25S	1.25mmD Straight Hex Tool Short	\$40.00
HT2.0	2.0mmD Hex Tool Long	\$40.00
HT2.0S	2.0mmD Hex Tool Short	\$40.00
HT2.5	2.5mmD Hex Tool Long (with retentive O-ring)	\$40.00
HT2.5S	2.5mmD Hex Tool Short (with retentive O-ring)	\$40.00
9048-07	SwishPlant Insertion Tool	\$60.00
OCTT	Octagon Alignment Tool	\$60.00



HT1.25



HT2.0



HT2.5



9048-07



HT1.25S



HT2.0S



HT2.5S



OCTT

Hex Drills

Latch head connection for use with Surgical Motor

Code	Description	Price
HD1.25	1.25mmD Hex Drill	\$40.00
HD2.0	2.0mmD Hex Drill	\$40.00
HD2.5	2.5mmD Hex Drill (with retentive O-ring)	\$40.00



HD1.25



HD2.0



HD2.5

Insertion Instruments

Code	Description	Price
R	Ratchet	\$125.00
TW30	30Ncm Torque Wrench	\$125.00
TW35	35Ncm Torque Wrench	\$125.00
SSH2.5	2.5mmD Stainless Steel Handle (with retentive O-ring)	\$100.00
FMD	Fixture Mount Drill	\$80.00
PAR	Paralleling Tool 2.8/2.3	\$15.00
LDRILL	Locator Drill	\$30.00
DE	Drill Extender	\$40.00



R



TW30



TW35



SSH2.5



FMD



PAR



LDRILL



DE

Surgical Trays

Code	Description	Price
SPST	Empty Surgical Tray for SwishPlant Implants	\$350.00
SPCST	Complete Surgical Kit for SwishPlant Implants	\$2100.00

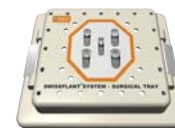

SPST



SPCST

Laboratory Tools

Code	Description	Price
ABH	Analog Holder	\$85.00



ABH



www.implantdirect.com
 Implant Direct Sybron International
 1-818-444-3333 • 1-888-NIZNICK



“Order Online for High Quality Products at Factory-Direct Prices”

Gerald Niznick, DMD,MSD, Founder and President of Implant Direct

SwishPlant™ All-in-One packaging

Includes: Cover Screw, Healing Collar, Transfer and Straight Abutment with Snap-on Comfort Cap.

SwishPlant USA price = \$200
 Straumann USA price = \$617



FEATURES AND BENEFITS

- 1.Body Design: Tapered with double-lead buttress threads
- 2.Surface/Body: SBM medium texture with 17 year history
- 3.Surface/Neck: SBM light texture for soft or hard tissue
- 4.Diameters: Standard 4.1mm and 4.8mm plus 3.3mm & 5.7mm
- 5.Platforms: Standard 4.8mm and 6.5mm internal octagon plus 3.7mm hex with Platform Switch
- 6.Fixture-mount/Transfer/Abutment: Engages square within octagon

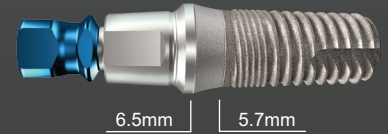
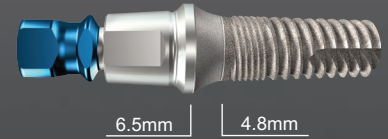
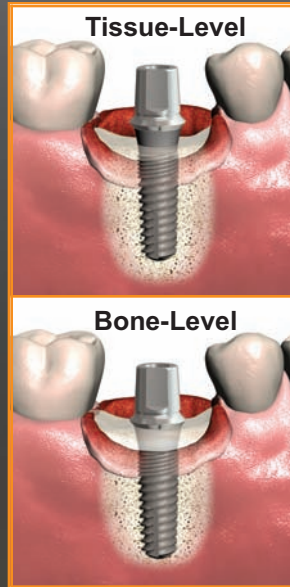

The 4.1mm and 4.8mm SwishPlant implants can be inserted into soft bone using Straumann's drills. An additional drill is required for dense bone or countersinking for bone-level placement. Implant Direct's ratchet, insertion tool and 1.25mmD hex tool are also required.

Recommended Introductory offer for ITI Straumann® users
 3 Free SwishPlant Implants with Internal connection, External Bevel, plus "Solid" Engaging Abutments and Transfers

US List Price for 3 Implants, Abutments and Prosthetic Components:

SwishPlant = \$700
ITI Straumann = \$1995

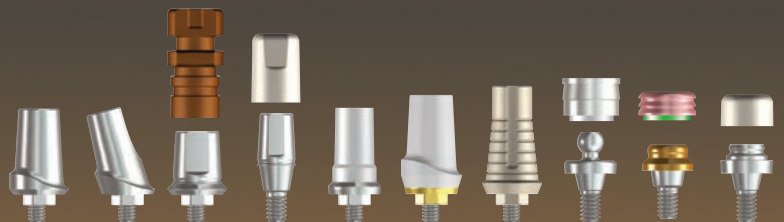

Compare US List Price	Preparable Covers Bevel	15° Angled Contoured	Straight Snap-On	Straight Solid Abutment	Gold/Plastic	Zirconia Abutment	Temporary Abutment	Ball Attachment	GPS™ Attachment	Screw Receiving
Implant Direct	\$85	\$85	\$85	\$100	\$100	\$120	\$35	\$107	\$100	\$85
ITI Straumann	\$182	\$203	\$190	\$237	\$148	*\$339	\$61	\$192	\$184	\$169
Cost Savings	53%	58%	55%	58%	33%	65%	43%	44%	46%	50%

FREE Introductory Offers at
www.implantdirect.com
 Terms and Conditions Apply

Straumann® Dental Implant System is a registered trademark of Institut Straumann AG, Switzerland
 *Comparison based upon Straumann's CARES Custom Zirconia Abutment. Price varies depending upon the laboratory.

List prices as of April 2010