

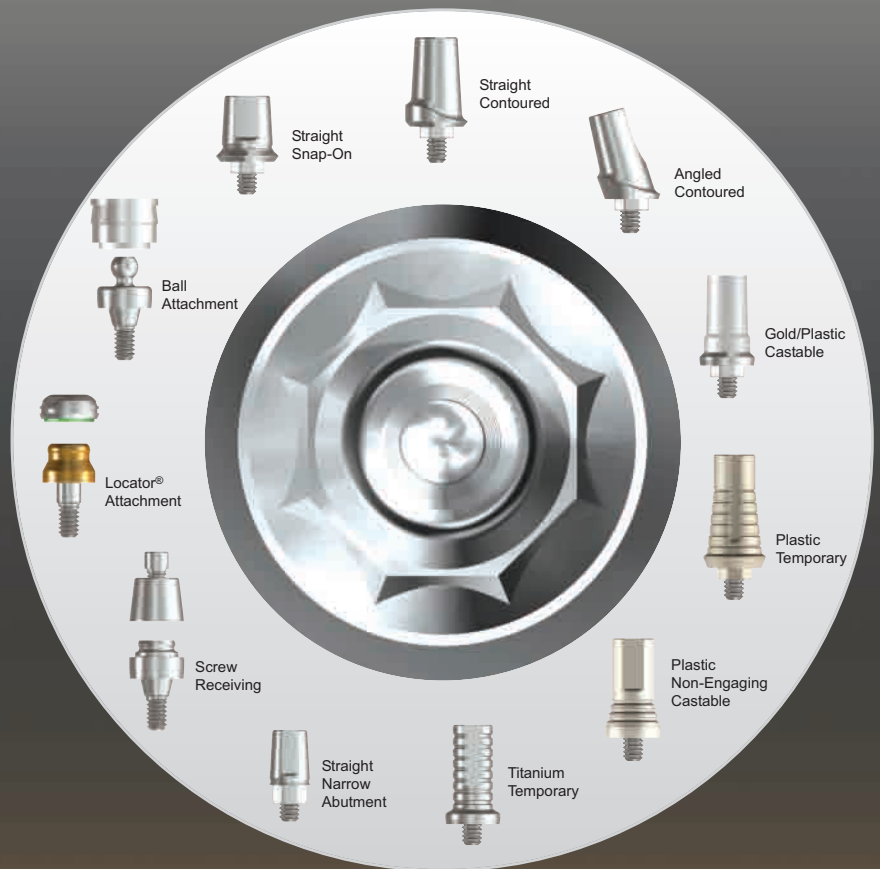

Implant
Direct™

simply smarter.

SwissPlant™ Prosthetic Catalog



SwissPlant™



SwissPlant Fixture-Mount Packaging

SwissPlant Implants are mounted on color-coded fixture-mounts, designed for use as implant level transfers or shortened to function as straight abutments. A cover screw and implant extender is included in each vial. The SwissPlant fixture-mount is provided with a snap-on comfort cap.



Prepare surgical site with drill



All of Implant Direct's implants come in a sterile vial



Each label is color-coded with two tear-off labels



Each cap is color coded by platform diameter of implant

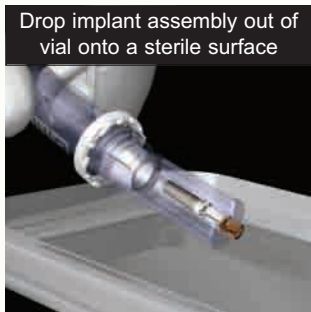

Drop implant assembly out of vial onto a sterile surface



Remove implant assembly with a fixture-mount drill or ratchet



Insert implant into osteotomy

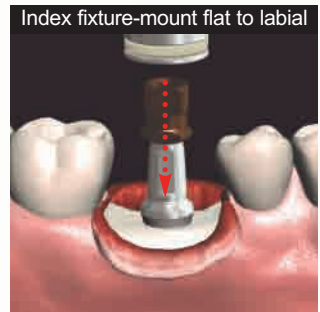

Index fixture-mount flat to labial



Remove fixture-mount

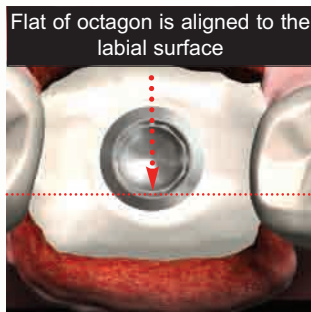

Flat of octagon is aligned to the labial surface



Remove the holder containing the cover screw & comfort cap



Snap-on comfort cap is located in the top portion of holder

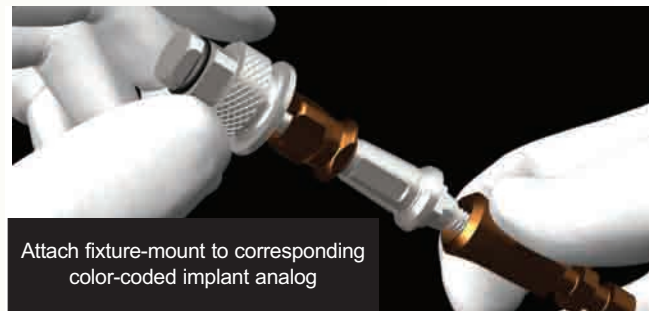

Attach fixture-mount to corresponding color-coded implant analog

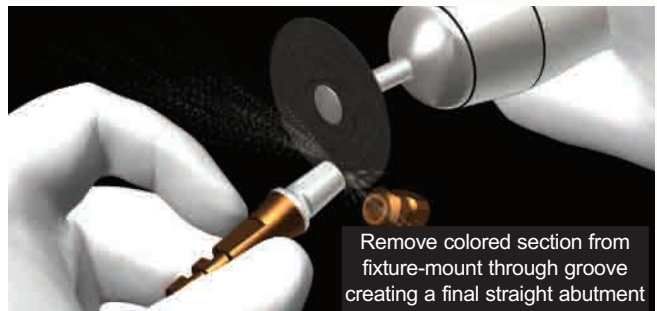

Remove colored section from fixture-mount through groove creating a final straight abutment



Use 30Ncm in hard bone. In soft bone, only use finger pressure



Check for occlusal clearance prior to attaching comfort cap



Test retention and rotate if necessary to increase retention



Suture soft tissue around comfort cap



Cover Screws, Healing Collars, Transfers & Analogs

Surgical Cover Screws

* Only for use with SwissPlant Implants - use 1.25mmD Hex Tool
 * Can be used with Straumann Insertion Tool

Code	Platform	Price
9037-01	* 3.7mmD	\$20.00
9048-01	* 4.8mmD	\$20.00
9065-01	* 6.5mmD	\$20.00
9048-01S	* 4.8mmD	\$20.00
9065-01S	* 6.5mmD	\$20.00

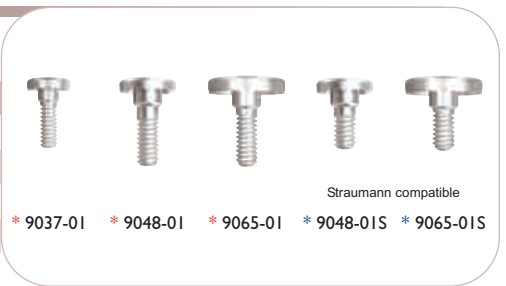

Healing Collars

Requires 1.25mmD Hex Tool
 "PS" for Platform Switching Interface

Code	Platform	Width	Length	Price
8530-13	3.7mmD PS	3.7mmD	3mmL	\$30.00
8530-15	3.7mmD PS	3.7mmD	5mmL	\$30.00
9037-12	3.7mmD	3.7mmD	2mmL	\$30.00
9037-13	3.7mmD	3.7mmD	3mmL	\$30.00
9048-12N	4.8mmD	5.1mmD	2mmL	\$30.00
9048-13N	4.8mmD	5.1mmD	3mmL	\$30.00
9048-12	4.8mmD	5.8mmD	2mmL	\$30.00
9048-13	4.8mmD	5.8mmD	3mmL	\$30.00
9065-12	6.5mmD	6.5mmD	2mmL	\$30.00
9065-13	6.5mmD	6.5mmD	3mmL	\$30.00



Closed-Tray Implant Transfers

Price includes Fixation Screw with 1.25mmD Hex

Code	Platform	Replacement Screw	Price
9037-05	3.7mmD	1000-09	\$30.00
9048-05N	4.8mmD	1000-17	\$30.00
9048-05	4.8mmD	1000-17	\$30.00
9065-05	6.5mmD	1000-17	\$30.00



Open-Tray Implant Transfers

Price includes Fixation Screw with 1.25mmD Hex

Code	Platform	Replacement Screw	Price
9037-08	3.7mmD	1000-26	\$30.00
9048-08N	4.8mmD	1000-18	\$30.00
9048-08	4.8mmD	1000-18	\$30.00
9065-08	6.5mmD	1000-18	\$30.00



Implant Analogs

Code	Platform	Price
9037-06	3.7mmD	\$20.00
9048-06	4.8mmD	\$20.00
9065-06	6.5mmD	\$20.00



Replacement Fixation Screws





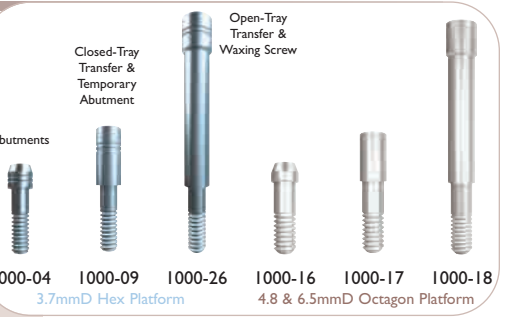





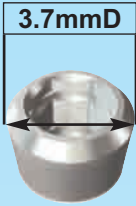













Requires 1.25mmD Hex Tool

Code	Description	Price (includes two pieces)
1000-04	For use with 3.7 hexagon platform	\$30.00
1000-09	For use with 3.7 hexagon platform	\$30.00
1000-26	For use with 3.7 hexagon platform	\$30.00
1000-16	For use with 4.8 & 6.5mmD octagon platforms	\$30.00
1000-17	For use with 4.8 & 6.5mmD octagon platforms	\$30.00
1000-18	For use with 4.8 & 6.5mmD octagon platforms	\$30.00





Selection Chart: Straight Abutments (Snap-On), Transfers & Analogs

3.7mmD Platform		4.8mmD Platform		6.5mmD Platform			
							
  <p>Implant Transfer closed-tray 9037-05 open-tray 9037-08</p>		  <p>Implant Transfer closed-tray 9048-05N open-tray 9048-08N</p>		 <p>Implant Transfer closed-tray 9048-05 open-tray 9048-08 Flared 4.8 to 5.7</p>		  <p>Implant Transfer closed-tray 9065-05 open-tray 9065-08</p>	
<p>Fixture-mount/Transfer</p>		<p>Fixture-mount/Transfer</p>		<p>Fixture-mount/Transfer</p>			
 <p>Implant Analog 9037-06</p>		 <p>Implant Analog 9048-06</p>		 <p>Implant Analog 9065-06</p>			
<p>Straight Abutment</p> <p>Covered bevel narrow profile</p> <p>Exposed bevel platform switching</p>   <p>OR</p>  <p>9037-21 8530-21</p>		<p>Straight Abutments</p> <p>Covered bevel narrow profile</p> <p>Exposed bevel</p> <p>2-piece Abutment</p> <p>1-piece Solid Abutment</p>    <p>OR</p>  <p>9048-21N 9048-20 9048-20-1</p>		<p>Straight Abutments with Flared Collars 4.8 to 5.7</p> <p>Covered bevel</p> <p>0.5mL cuff</p>   <p>2mL cuff</p> <p>9048-21 9048-22</p>		<p>Straight Abutments</p> <p>Exposed bevel</p> <p>2-piece Abutment</p> <p>1-piece Solid Abutment</p>   <p>OR</p>  <p>9065-20 9065-20-1</p>	
 <p>Straight Abutment Transfer 9037-02</p>		 <p>Straight Abutment Transfer 9047-02</p>		 <p>Straight Abutment Transfer 3057-02</p>		 <p>Straight Abutment Transfer 3065-02</p>	
  <p>Comfort Cap 3037-26 Castable Coping 3037-28</p>		  <p>Comfort Cap 3047-26 Castable Coping 3047-28</p>		  <p>Comfort Cap 3057-26 Castable Coping 3057-28</p>		  <p>Comfort Cap 3065-26 Castable Coping 3065-28</p>	
<p>Straight Abutment Analog 9037 incl. Castable Coping</p>  		<p>Straight Abutment Analog 9047 incl. Castable Coping</p>  		<p>Straight Abutment Analog 3057 incl. Castable Coping</p>  		<p>Straight Abutment Analog 3065 incl. Castable Coping</p>  	



Straight Abutments, Snap-on Transfers and Lab Analogs

Straight Abutments

Includes Transfer, Comfort Cap & Fixation Screw with 1.25mmD Hex
 "PS" for Platform Switching Interface

Code	Platform	Collar Heights	Use Analog	Price
8530-21	3.7mmD PS	1.0mm	3037	\$85.00
8530-22	3.7mmD PS	2.0mm	3037	\$85.00
8530-23	3.7mmD PS	3.0mm	3037	\$85.00
9037-21	3.7mmD	0.5mm	3037	\$85.00
9037-22	3.7mmD	2.0mm	3037	\$85.00
9048-21N	4.8mmD	0.5mm	9047	\$85.00
9048-22N	4.8mmD	2.0mm	9047	\$85.00
9048-21	4.8mmD	0.5mm	3057	\$85.00
9048-22	4.8mmD	2.0mm	3057	\$85.00

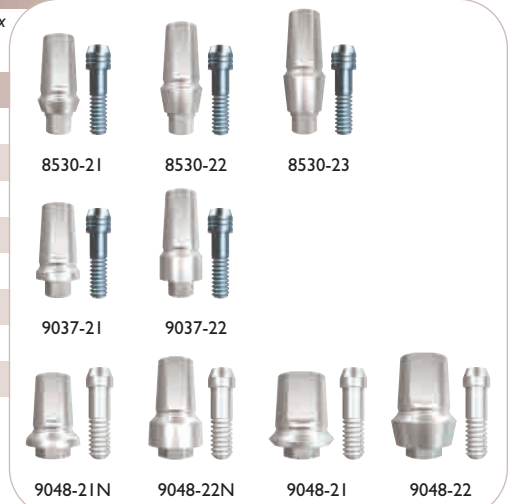

Straight Abutments - Exposed Bevel

Includes Transfer, Comfort Cap & Fixation Screw with 1.25mmD Hex

Code	Platform	Abutment Kit	Price
9048-20	4.8mmD	Includes Analog 9047	\$110.00
9048-20-1	4.8mmD	Includes Analog 9047	\$100.00
9065-20	6.5mmD	Includes Analog 3065	\$110.00
9065-20-1	6.5mmD	Includes Analog 3065	\$100.00



Straight Abutment Transfers

Code	Abutment Width	Price (includes two pieces)
9037-02	3.7mmD	\$30.00
9047-02	4.7mmD	\$30.00
3057-02	5.7mmD	\$30.00
3065-02	6.5mmD	\$30.00



Straight Abutment Comfort Caps

Code	Abutment Width	Price (includes two pieces)
3037-26	3.7mmD	\$30.00
3047-26	4.7mmD	\$30.00
3057-26	5.7mmD	\$30.00
3065-26	6.5mmD	\$30.00



Straight Abutment Analogs

Includes Castable Coping

Code	Abutment Width	Price
9037	3.7mmD	\$35.00
9047	4.7mmD	\$35.00
3057	5.7mmD	\$35.00
3065	6.5mmD	\$35.00



Straight Abutment Castable Coping

Code	Abutment Width	Price (includes two pieces)
3037-28	3.7mmD	\$30.00
3047-28	4.7mmD	\$30.00
3057-28	5.7mmD	\$30.00
3065-28	6.5mmD	\$30.00

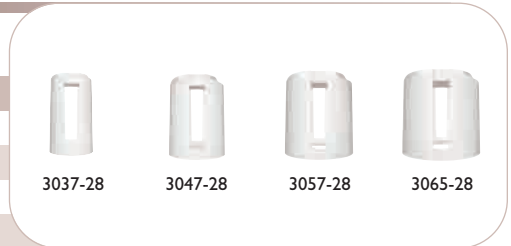



Selection Chart: Abutments for Cemented Restorations

3.7mmD Platform

3.7mmD

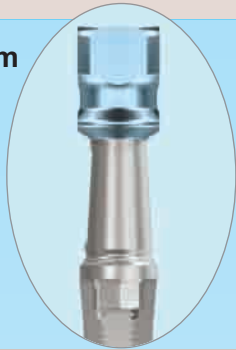

4.8mmD Platform

4.8mmD

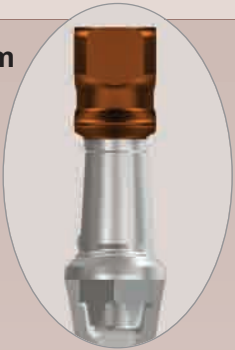

6.5mmD Platform

6.5mmD



Narrow Straight Abutment with Bevel Covered

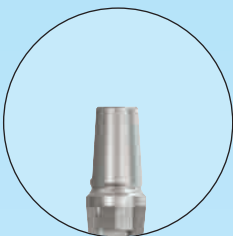

0.5mm Collar
9037-21
2mm = 9037-22

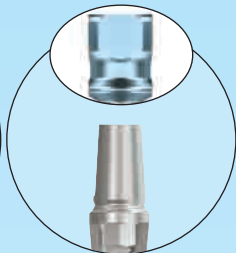

Shorten
Fixture-mount
duplicates 9037-21



0.5mm Collar
9048-21N
2mm = 9048-22N



Shorten
Fixture-mount
duplicates 9048-21N

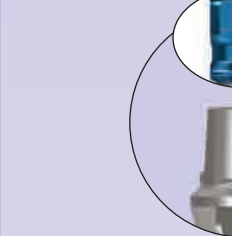

Shorten
Fixture-mount
for 1.0mm Collar

Narrow Straight Abutment with Bevel Exposed

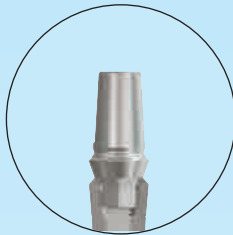

2-Piece Hex
Engaging Abutment
8530-21



2-Piece Octagon
Engaging Abutment
9048-20

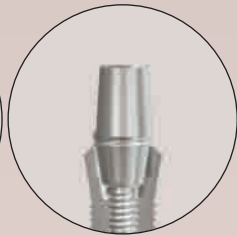

1-Piece Solid
Abutment
9048-20-1



2-Piece Octagon
Engaging Abutment
9065-20

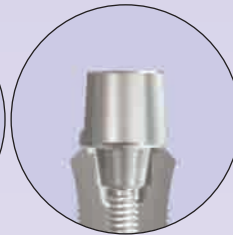

1-Piece Solid
Abutment
9065-20-1

Straight and Angled Platform Switching Abutments with Contoured Margins

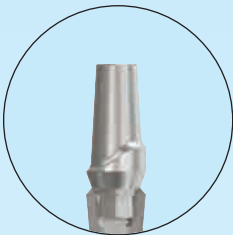

1mm Collar
8530-31
2mm = 8530-32

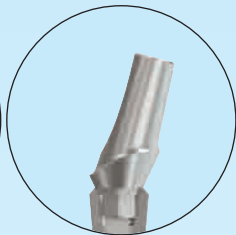

0.75mm Collar
8530-51
2mm = 8530-52



0.75mm Collar
9048-31P

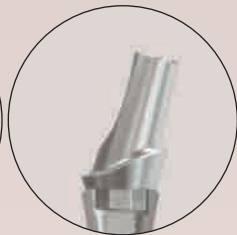

0.75mm Collar
9048-51P



0.75mm Collar
9065-31P

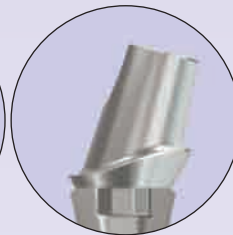

0.75mm Collar
9065-51P

4.8mmD Platform Straight and Angled Abutments with Flared Collars



Straight Snap-on
Abutment
0.5mm Collar
9048-21



Straight Snap-on
Abutment
2mm Collar
9048-22



Straight Contoured
Abutment
0.5mm Collar
9048-31

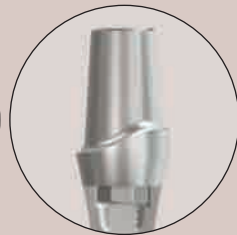

Straight Contoured
Abutment
2mm Collar
9048-32

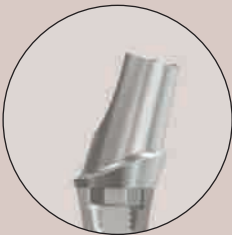

Angled Contoured
Abutment
0.5mm Collar
9048-51

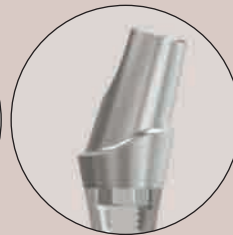

Angled Contoured
Abutment
2mm Collar
9048-52



Gold, Plastic and Titanium Engaging and Non-Engaging Abutments

Gold Engaging Cast-to Abutments

Price includes Fixation Screw with 1.25mmD Hex
 "PS" for Platform Switching Interface

Code	Platform	Collar Heights	Replacement Screw	Price
8530-40	3.7mmD PS	1.0mm	1000-04	\$100.00
9048-40	4.8mmD	1.0mm	1000-16	\$100.00

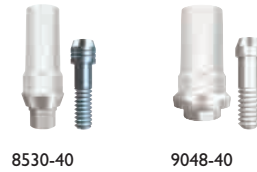

Gold Non-Engaging Cast-to Abutments

Price includes Fixation Screw with 1.25mmD Hex

Code	Platform	Collar Heights	Replacement Screw	Price
8530-41	3.7mmD PS	1.0mm	1000-04	\$100.00
9048-41	4.8mmD	1.0mm	1000-16	\$100.00



Plastic Non-Engaging Castable Abutments

Price includes Fixation Screw with 1.25mmD Hex

Code	Platform	Collar Heights	Replacement Screw	Price
8530-46	3.7mmD PS	1.0mm	1000-04	\$30.00
9048-46	4.8mmD	1.0mm	1000-16	\$30.00
9065-46	6.5mmD	1.0mm	1000-16	\$30.00



Plastic Engaging Temporary Abutments

Price includes Fixation Screw with 1.25mmD Hex

Code	Platform	Collar Heights	Replacement Screw	Price
8530-47	3.7mmD PS	1.0mm	1000-09	\$35.00
9048-47	4.8mmD	1.0mm	1000-17	\$35.00
9065-47	6.5mmD	1.0mm	1000-17	\$35.00



Titanium Non-Engaging Temporary Abutments

Price includes Fixation Screw with 1.25mmD Hex

Code	Platform	Collar Heights	Replacement Screw	Price
8530-49	3.7mmD PS	1.0mm	1000-04	\$35.00
9048-49	4.8mmD	1.0mm	1000-16	\$35.00
9065-49	6.5mmD	1.0mm	1000-16	\$35.00



Straight Contoured Abutments

Price includes Fixation Screw with 1.25mmD Hex

Code	Platform	Collar Heights	Replacement Screw	Price
8530-31	3.7mmD PS	1.0 mm	1000-04	\$85.00
8530-32	3.7mmD PS	2.0 mm	1000-04	\$85.00
9048-31	4.8mmD	0.5 mm	1000-16	\$85.00
9048-32	4.8mmD	2.0 mm	1000-16	\$85.00
9048-31P	4.8mmD PS	0.75mm	1000-16	\$85.00
9065-31P	6.5mmD PS	0.75mm	1000-16	\$85.00



Angled Contoured Abutments

Price includes Fixation Screw with 1.25mmD Hex

Code	Platform	Collar Heights	Replacement Screw	Price
8530-51	3.7mmD PS	0.75mm	1000-04	\$85.00
8530-52	3.7mmD PS	2.0 mm	1000-04	\$85.00
9048-51	4.8mmD	0.5 mm	1000-16	\$85.00
9048-52	4.8mmD	2.0 mm	1000-16	\$85.00
9048-51P	4.8mmD PS	0.75mm	1000-16	\$85.00
9065-51P	6.5mmD PS	0.75mm	1000-16	\$85.00





Selection Chart: Overdenture & Screw-Retained Restorations

3.7mmD Platform



4.8mmD Platform



Overdenture Abutments (*Includes Transfer and Comfort Cap)

Overdenture Abutments



9037-61



9037-62



9037-63



9048-61



9048-62



9048-63



9048-64

Overdenture Abutment Transfer, Analog & Comfort Cap

OD Abutment Comfort Cap Transfer and Analogs



*4000-13



*1000-68



1000-61



Open-Tray Transfer

1000-62

Closed-Tray Transfer



1000-63

Overdenture Copings

Overdenture Abutment Components



1000-64

Gold



1000-65

Titanium



1000-66

Plastic



1000-67

Gold/Plastic



1000-69

Titanium

Ball Abutments (**Includes Transfer and Comfort Cap)

Ball Abutments



9037-71



9037-72



9037-73



9048-71



9048-72



9048-73

Ball Attachments

Ball Abutment Components



**1000-87



**1000-84



1000-85



1000-81



1000-82



1000-88



1000-83



1000-86

Locator® Abutments

Locator® Abutments



9037-91



9037-92



9037-93



9048-91



9048-92



9048-93

Locator® Attachments

Locator® Abutment Components



1000-94



1000-95

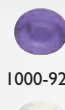

1000-92B

1000-92C

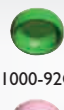

1000-92G

1000-92P



1000-92R



1000-98



1000-93



1000-96

Abutments are compatible with Straumann Implants with 4.8mmD and 6.5mmD prosthetic platforms



Prosthetic Components for Overdenture & Screw-Retained Restorations

Overdenture Abutments

Includes Transfer & Comfort Cap - requires 1.25mmD Hex Tool

Code	Platform	Collar Heights	Price
9037-61	3.7mmD	1mm	\$85.00
9037-62	3.7mmD	2mm	\$85.00
9037-63	3.7mmD	3mm	\$85.00
9048-61	4.8mmD	1mm	\$85.00
9048-62	4.8mmD	2mm	\$85.00
9048-63	4.8mmD	3mm	\$85.00
9048-64	4.8mmD	4mm	\$85.00

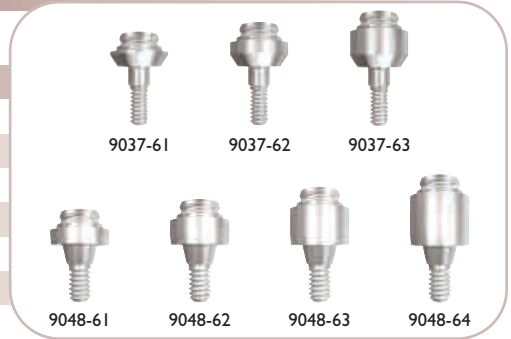

Ball Abutments

Includes Transfer & Comfort Cap - requires 1.25mmD Hex Tool

Code	Platform	Collar Heights	Price
9037-71	3.7mmD	1mm	\$85.00
9037-72	3.7mmD	2mm	\$85.00
9037-73	3.7mmD	3mm	\$85.00
9048-71	4.8mmD	1mm	\$85.00
9048-72	4.8mmD	2mm	\$85.00
9048-73	4.8mmD	3mm	\$85.00

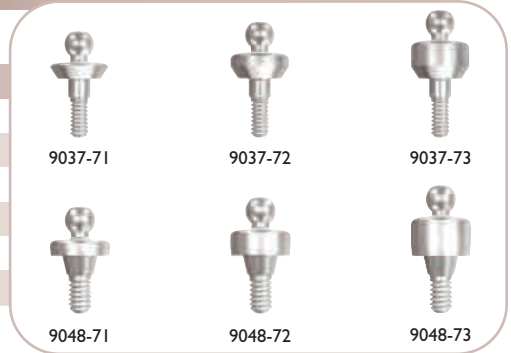

Overdenture Abutment Comfort Cap, Transfers & Analog

Screws require 1.25mmD Hex Tool

Code	Prosthetic Platform	Description	Price
1000-61	5.0mmD	Aluminum Analog	\$20.00
1000-62	5.0mmD	Open-Tray Transfer plus Fixation Screw	\$30.00
1000-63	5.0mmD	Closed-Tray Transfer plus Fixation Screw	\$30.00
1000-68	5.0mmD	Plastic Abutment Transfer - 2ea	\$30.00
4000-13	5.0mmD	Plastic Comfort Cap - 2ea	\$30.00
1000-14	-	Replacement Open-Tray Fixation Screw - 2ea	\$30.00
1000-15	-	Replacement Closed-Tray Fixation Screw - 2ea	\$30.00

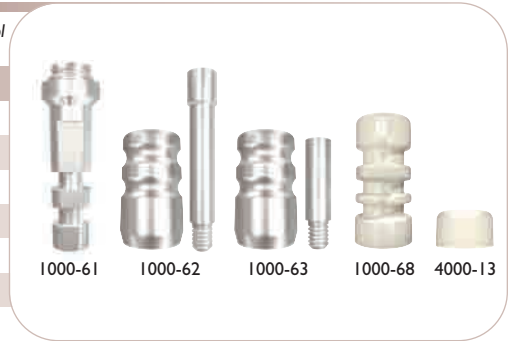

Overdenture Abutment Components

Price includes Fixation Screw [1000-05] with 1.25mmD Hex

Code	Prosthetic Platform	Description	Price
1000-05	-	Coping Replacement Fixation Screw - 2ea	\$30.00
1000-64	5.0mmD	Gold Coping	\$75.00
1000-65	5.0mmD	Titanium Coping	\$40.00
1000-66	5.0mmD	Plastic Coping	\$35.00
1000-67	5.0mmD	Gold & Plastic Coping	\$75.00
1000-69	5.0mmD	Titanium Temporary Coping	\$35.00

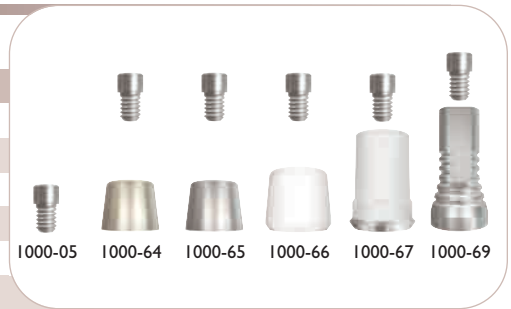

Ball Abutment Components

Code	Description	Price
1000-81	Ball Abutment Housing - 2ea	\$30.00
1000-82	Nylon Liner - 2ea	\$15.00
1000-83	Nylon Liner Transfers - 2ea	\$15.00
1000-84	Ball Abutment Transfer - 2ea	\$30.00
1000-85	Ball Abutment Analog	\$20.00
1000-86	Ball Abutment Tools	\$65.00
1000-87	Ball Abutment Comfort Cap - 2ea	\$30.00
1000-88	Ball Abutment Housing & Nylon Liner	\$22.00

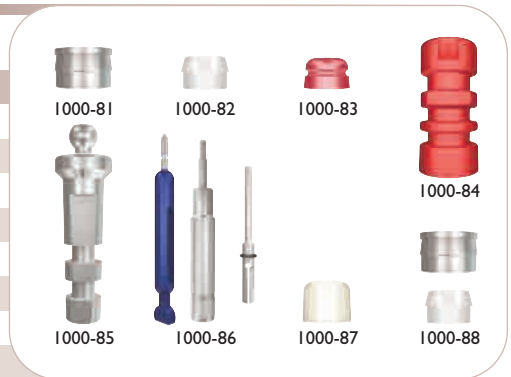



Locator® Abutments, Prosthetic Components & Ancillary Products

SwissPlant Locator® Abutments

Requires purchase of Abutment Processing Cap/Male Kit [1000-98]

Code	Platform	Collar Heights	Price
9037-91	3.7mmD	1mm	\$110.00
9037-92	3.7mmD	2mm	\$110.00
9037-93	3.7mmD	3mm	\$110.00
9048-91	4.8mmD	1mm	\$110.00
9048-92	4.8mmD	2mm	\$110.00
9048-93	4.8mmD	3mm	\$110.00

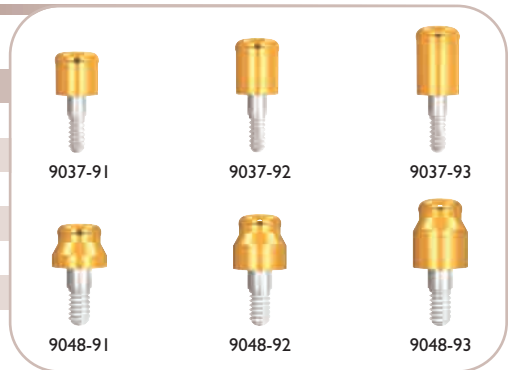

Locator® Abutment Transfer, Analogs and Alignment Tools

Code	Description	Price
1000-94	Locator® Impression Coping - 2ea	\$32.00
1000-95	Locator® Abutment Analog 4mmD - 2ea	\$32.00
1000-95W	Locator® Abutment Analog 5mmD - 2ea	\$32.00
1000-97	Locator® Abutment Parallel Post - 4ea	\$16.00
1000-18	Guide Screw for SwissPlant 4.8mmD Platform - 2ea	\$30.00
1000-99	Locator® Abutment Angle Measure Guide	\$21.00



Locator® Abutment Components

Code	Retention Force	Description	Price
1000-92C	5.0lbs	Replacement Male Clear - 4ea	\$21.00
1000-92P	3.0lbs	Light Replacement Male Pink - 4ea	\$21.00
1000-92B	1.5lbs	Extra Light Replacement Male Blue - 4ea	\$21.00
1000-92G	4.0lbs	Extended Range Male Green - 4ea	\$21.00
1000-92R	1.0lb	Extra Light Extended Range Male Red - 4ea	\$21.00
1000-93	-	Black Processing Male - 4ea	\$21.00
1000-98	Assorted	Abutment Processing Cap/Male Kit - 2ea	\$58.00



Locator® Instrumentation

Code	Description	Price
LDT	Locator® Abutment Driver Tool - Long	\$44.00
LDS	Locator® Abutment Driver Tool - Short	\$44.00
LDD	Locator® Abutment Driver Drill - Long	\$44.00
LDSD	Locator® Abutment Driver Drill - Short	\$44.00
1000-96	Core Tool - Male Removal & Seating Tool and Abutment Driver	\$75.00

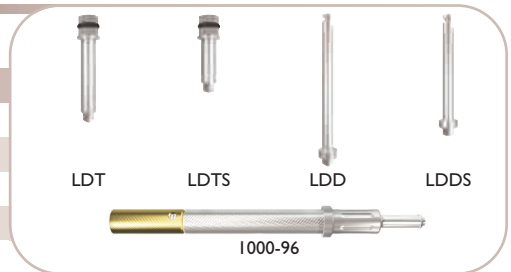



Prosthetic Instruments

Tapered Hex Tools

Code	Description	Price
THT1.25	1.25mmD Tapered Hex Tool Long	\$40.00
THT1.25S	1.25mmD Tapered Hex Tool Short	\$40.00



THT1.25



THT1.25S

Straight Tools

Square connection for use with Ratchet or Torque Wrench

Code	Description	Price
HT1.25	1.25mmD Straight Hex Tool Long	\$40.00
HT1.25S	1.25mmD Straight Hex Tool Short	\$40.00
HT2.5	2.5mmD Hex Tool Long (with retentive O-ring)	\$40.00
HT2.5S	2.5mmD Hex Tool Short (with retentive O-ring)	\$40.00
9048-07	SwissPlant Insertion Tool	\$60.00
OCTT	Octagon Alignment Tool	\$60.00



HT1.25



HT2.5



9048-07



HT1.25S



HT2.5S



OCTT

Hex Drills

Latch head connection for use with Surgical Motor

Code	Description	Price
HD1.25	1.25mmD Hex Drill	\$40.00
HD2.5	2.5mmD Hex Drill (with retentive O-ring)	\$40.00



HD1.25



HD2.5

Ancillary Instruments

Code	Description	Price
TW30	30Ncm Torque Wrench	\$125.00
TW35	35Ncm Torque Wrench	\$125.00
DE	Drill Extender	\$40.00
TWM	Multi-Setting Torque Wrench (15, 20, 25, 30, 35, 40, 45, 50 & 60Ncm)	\$395.00
ABH	Analog Holder	\$85.00



TW30



TW35



DE



TWM



ABH



Implant Direct™

simply smarter.

27030 Malibu Hills Road,
Calabasas Hills, CA 91301
Phone: 1-818-444-3333

www.implantdirect.com



“Order Online for High Quality Products at factory-direct prices”

Gerald Niznick, DMD, MSD, Founder and President of Implant Direct

SwissPlant's All-in-One packaging includes: Cover Screw, Healing Collar, Transfer and Straight Abutment with Snap-on Comfort Cap
SwissPlant USA price = \$200
Straumann USA price = \$610-\$660



FEATURES AND BENEFITS

1. Body Design: Tapered with Mini-threads & progressively deeper, double-lead buttress threads
2. Surface/Body: SBM Medium Texture with 17 year history
3. Surface/Neck: SBM Light Texture for soft or hard tissue
4. Diameters: Standard 4.1mm and 4.8mm plus 3.3mm & 5.7mm
5. Platforms: Standard 4.8mm and 6.5mm internal octagon plus 3.7mm hex with Platform Switch
6. Fixture-mount/Transfer/Abutment: Engages square within octagon

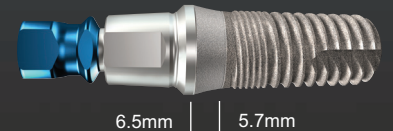
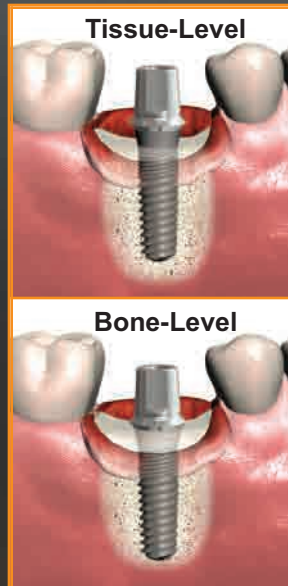

* The 4.1mm and 4.8mm SwissPlant implants can be inserted into soft bone using Straumann's drills. An additional drill is required for dense bone or countersinking for bone-level placement. Implant Direct's ratchet, insertion tool and 1.25mmD hex tool are also required.

Recommended Introductory offer for ITI Straumann® users
3 Free SwissPlant Implants with Internal connection, External Bevel, plus "Solid" Engaging Abutments and Transfers

US List Price for 3 Implants, Abutments and Prosthetic Components:
SwissPlant = \$690
Straumann = \$2032



Compare US List Price	Preparable Covers Bevel	Preparable Platform Switch	15° Angled	Straight Snap-On	Straight Solid Abutment	Gold/Plastic	Temporary Abutment	Ball Attachment	Screw Receiving	Locator® Abutment
Implant Direct	\$85	\$85	\$85	\$85	\$85	\$100	\$35	\$107	\$85	\$138
ITI Straumann	\$182	\$182	\$203	\$185	\$185	\$211	\$61	\$162	\$182	\$138
Cost Savings	59%	59%	58%	54%	54%	53%	43%	44%	53%	0%

FREE Introductory Offers at
www.implantdirect.com
 Terms and Conditions Apply